



Operation & Maintenance Manual

Compressor Module HP60CMH



This manual contains important safety information.

Do not destroy this manual.

This manual must be available to the personnel who operate and maintain this machine.

American Hydraulic Compressor
PO Box 158
Palisade CO 81526
970-640-7223
www.am-hc.com

23108186

TABLE OF CONTENTS

Operation & Maintenance Manual

TITLE	PAGE
SAFETY	5
Safety Precautions	6
General Information	6
Safety Labels	9
 INSTALLATION	 17
System Description - General	18
Mounting Unit	19
Inlet Piping	19
Piping - General	20
Compressor Discharge Piping	20
Wiring	20
Regulation	21
Hydraulic Cooling Requirements	21
Hydraulic Oil Requirements	21
Hydraulic Reservoir	22
Hydraulic Filtration	22
HP60CMH Hydraulic Flow Schematic	22
 GENERAL DATA	 23
Unit Models	24
 OPERATING INSTRUCTIONS	 25
Set-Up	26
Before Starting	26
Starting/Operating	27
Stopping	28
Equipment Protection	28
High Discharge Air Temperature	28
Operating Instruments	29
On Panel	29
Inside	29
Speed and Pressure Regulator Adjusting Instructions	29
Before Starting	29
After Starting Unit	30

TABLE OF CONTENTS
Operation & Maintenance Manual

TITLE	PAGE
MAINTENANCE/LUBRICATION	31
General	32
Scheduled Maintenance	32
Compressor Oil	32
Compressor Oil Level	33
Aircleaner	33
Gauges	33
Compressor Oil and Hydraulic Oil Combination Cooler	34
Hoses	34
Compressor Oil Filter	35
Fasteners	36
Receiver-Separator Systems	36
Scavenge Line	37
Oil Separator Element	37
Exterior Finish Care	38
Drive Belt	39
Field Repair Texture Paint	39
Maintenance Schedule	41
 LUBRICATION	 43
General Information	44
Compressor Oil Change	45
Portable Compressor Fluid Chart	46
 TROUBLE SHOOTING	 49
Introduction	50
Action Plan	50
Think Before Acting	50
Do the Simplest Things First	50
Double Check Before Disassembly	51
Find and Correct Basic Cause	51
Trouble Shooting Chart	52



Safety

Safety

Safety Precautions

General Information

Ensure that the operator reads and understands the decals and consults the manuals before maintenance operation.

Ensure that the Operation and Maintenance manual, and the manual holder if equipped, are not removed permanently from the machine.

Ensure that maintenance personnel are adequately trained, competent and have read the manuals.

Make sure that all protective covers are in place and that the canopy / doors are closed during operation.

The specification of this machine is such that the machine is not suitable for use in flammable gas risk areas. If such an application is required then all local regulations, codes of practice and site rules must be observed. To ensure that the machine can operate in a safe and reliable manner, additional equipment such as gas detection, exhaust spark arrestors, and intake (shut - off) valves may be required, dependent on local regulations or the degree of risk involved.

Air discharged from this machine may contain carbon monoxide or other contaminants, which will cause serious injury or death. Do not breathe this air.

Compressed air can be dangerous if incorrectly handled. Before doing any work on the unit, ensure that all pressure is vented from the system and that the machine cannot be started accidentally.

Ensure that the machine is operating at the rated pressure and that all relevant personnel know the rated pressure.

All air pressure equipment installed in or connected to the machine must have safe working pressure ratings of at least the machine safety valve rating.

If more than one compressor is connected to one common downstream plant, effective check valves and isolation valves must be fitted and controlled by work procedures, so that one machine cannot accidentally be pressurized or over pressurized by another.

Compressed air must not be used for a feed to any form of breathing apparatus or mask.

The discharged air contains a very small percentage of compressor lubricating oil and care should be taken to ensure that downstream equipment is compatible.

If the discharged air is to be ultimately released into a confined space, adequate ventilation must be provided.

When using compressed air, always use appropriate personal protective equipment.

All pressure containing parts, especially flexible hoses and their couplings, must be regularly inspected, be free from defects and be replaced according to the Manual instructions.

Avoid bodily contact with compressed air.

The safety valve located in the separator tank must be checked periodically for correct operation.

Never operate unit without first observing all safety warnings and carefully reading the operation and maintenance manual shipped from the factory with this machine.

Never operate the engine of this machine inside a building without adequate ventilation. Avoid breathing exhaust fumes when working on or near the machine. Do not alter or modify this machine.

A battery contains sulfuric acid and can give off gases, which are corrosive and potentially explosive. Avoid contact with skin, eyes and clothing. In case of contact, flush area immediately with water.

Exercise extreme caution when using booster battery. To jump battery, connect ends of one booster cable to the positive (+) terminal of each battery. Connect one end of other cable to the negative (-) terminal of the booster battery and other end to a ground connection away from dead battery (to avoid a spark occurring near any explosive gases that may be present). After starting unit, always disconnect cables in reverse order.

Never operate unit without first observing all safety warnings and carefully reading the operation and maintenance manual shipped from the factory with this machine.

This machine may include such materials as oil, diesel fuel, antifreeze, brake fluid, oil / air filters and batteries which may require proper disposal when performing maintenance and service tasks. Contact local authorities for proper disposal of these materials.

Air discharged from this machine may contain carbon monoxide or other contaminants, which will cause serious injury or death. Do not breathe this air.

High Pressure Air can cause serious injury or death. Relieve pressure before removing filler plugs / caps, fittings or covers.

Air pressure can remain trapped in air supply line, which can result in serious injury or death. Always carefully vent air supply line at tool or vent valve before performing any service.

This machine produces loud noise with the doors open or service valve vented. Extended exposure to loud noise can cause hearing loss. Always wear hearing protection when doors are open or service valve is vented.

Never inspect or service unit without first disconnecting battery cable(s) to prevent accidental starting.

Do not remove the pressure cap from a HOT radiator. Allow radiator to cool down before removing pressure cap.

Do not use petroleum products (solvents or fuels) under high pressure as this can penetrate the skin and result in serious illness. Wear eye protection while cleaning unit with compressed air to prevent debris from injuring eye(s).

Disconnect air hoses whip and can cause serious injury or death. Always attach a safety flow restrictor to each hose at the source of supply or branch line in accordance with OSHA Regulation 29CFR Section 1926.302 (b).

Hot pressurized fluid can cause serious burns. Do not open radiator while hot.

Rotating fan blade can cause serious injury. Do not operate without guard in place.

Use care to avoid contacting hot surfaces (engine exhaust manifold and piping, air receiver and air discharge piping, etc.).

Ether is an extremely volatile, highly flammable gas. USE SPARINGLY! If too much is injected, it may result in costly damage to the engine.

Never allow the unit to sit stopped with pressure in the receiver – separator system. As a precaution, open the manual blowdown valve.

Never operate unit with guards, covers or screens removed. Keep hands, hair, clothing, tools, etc. well away from moving parts.

Make sure wheels, tires and tow bar connectors are in safe operating condition and tow bar is properly connected before towing.

Whenever the machine is stopped, air will flow back into the compressor system from devices or systems downstream of the machine unless the service valve is closed. Install a check valve at the machine service valve to prevent reverse flow in the event of an unexpected shutdown when the service valve is open.

Hazardous Substance Precaution

The following substances are used in the manufacture of this machine and may be hazardous to health if used incorrectly.

Precaution: Avoid ingestion, skin contact and breathing fumes for the following substances: Antifreeze, Compressor Oil, Engine Lubricating Oil, Preservative Grease, Rust Preventative, Diesel Fuel and Battery Electrolyte. The following substances may be produced during the operation of this machine and may be hazardous to health:

Avoid build-up of Engine Exhaust Fumes in confined spaces.

- Avoid breathing Exhaust Fumes.
- Avoid breathing Brake Lining Dust during maintenance.

Free Safety Decals
<p>Do not paint over safety warnings or instructional decals. If safety warning decals become illegible, immediately order replacements from the factory. Safety Decals are identified by the decal heading: DANGER, WARNING, or CAUTION. Decal part numbers are on the bottom of each decal and are also listed in the compressor’s parts manual. Submit orders for Safety Decals to the American Hydraulic Compressor Service Department. Help promote safety! Assure that decals are present on the machines. Replace decals that are not readable.</p>

Safety Labels

Look for these signs on machines shipped to international markets outside North America, which point out potential hazards to the safety of you and others. Read and understand thoroughly. Heed warnings and instructions. If you do not understand, inform your supervisor.



Corrosion risk



Hot surface



Lifting point.



WARNING: Electrical shock risk



Parking Brake



No open flame

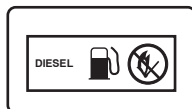

Diesel Fuel.
No open flame

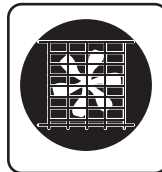

Do not operate the machine
without guard being fitted.



Lifting point.



WARNING - Flammable liquid

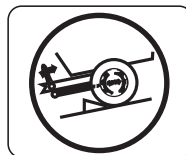

When parking use prop stand,
handbrake and wheel chocks

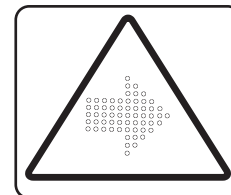

Air/gas flow or Air discharge.



WARNING - Hot and harmful
exhaust gas.



Tie down point



Do not breathe the compressed
air from this machine



Read the Operation and Maintenance manual before operation or maintenance of this machine is undertaken.

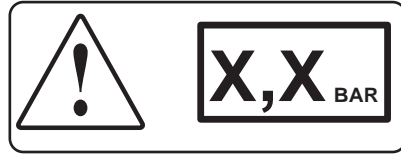

WARNING - Maintain correct tire pressure (Refer to the GENERAL INFORMATION section of this manual).

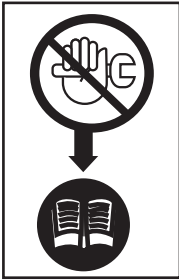

WARNING - Consult the operation and maintenance manual before commencing any maintenance.



Rough Service Designation
Wet Location Operation



Do not stack.

Do not use fork lift truck from this side.

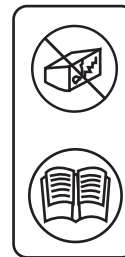

Replace any cracked protective shield.



WARNING - Before connecting the tow bar or preparing to tow, consult the operation and maintenance manual.



Do not operate with the doors or enclosure open



On (power).



Off (power).



Emergency stop

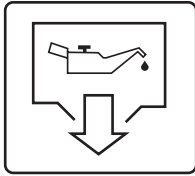

Oil Drain



Do not exceed the speed limit.

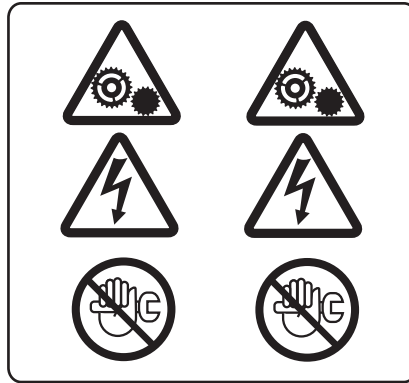

WARNING - Do not undertake any maintenance on this machine until the electrical supply is disconnected and the air pressure is totally relieved.

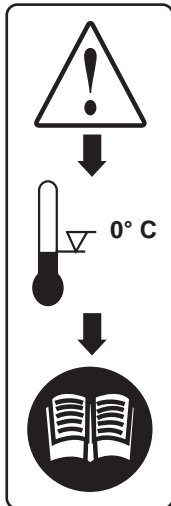

WARNING - For operating temperature below 0° C, consult the operation and maintenance manual



Read the Operation and Maintenance manual before operation or maintenance of this machine is undertaken.



Do not remove operating and maintenance manual and manual holder from this machine.

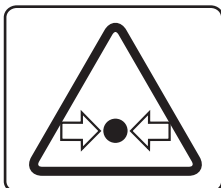

Pressurized vessel.



Use fork lift truck from this side only

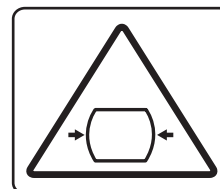

Pressurized component or system.

Look for these signs on machines shipped to international markets outside North America, which point out potential hazards to the safety of you and others. Read and understand thoroughly. Heed warnings and instructions. If you do not understand, inform your supervisor.



(Red Background)

Indicates the presence of a hazard which **WILL** cause serious injury, death or property damage, if ignored.



(Orange Background)

Indicates the presence of a hazard which **CAN** cause serious injury, death or property damage, if ignored.



(Yellow Background)

Indicates the presence of a hazard which **WILL** or can cause injury or property damage, if ignored.



(Blue Background)

Indicates important set-up, operating or maintenance information.



⚠ DANGER



Discharged air can contain carbon monoxide or other contaminants. Will cause serious injury or death.

Do not breathe this air.





⚠ WARNING

Trapped air pressure. Can cause serious injury or death

Close service valve and operate tool to vent trapped air before performing any service



⚠ WARNING

Hot pressurized fluid. Can cause severe burns.

Do not open radiator while hot.





⚠ WARNING

High pressure air. Can cause serious injury or death.

Relieve pressure before removing filler plugs/caps, fittings or covers.





! WARNING

**Improper operation of this equipment.
Can cause serious injury or death.**
Read Operator's Manual supplied with this machine before operation or servicing.

**Modification or alternation of this machine.
Can cause serious injury or death.**
Do not alter modify this machine without the express written consent of the manufacturer.

105
km/h

! WARNING

**Collapsing jackstand.
Can cause serious injury.** 

Insert locking pin completely.

**Excessive towing speed.
Can cause serious injury or death.** 



Do NOT exceed 65 mph (105 km/hr.)



! WARNING

**Rotating fan blade.
Can cause serious injury.** 

Do not operate without guard on place.

! WARNING

**Falling of machine.
Can cause serious injury or death.** 

Access lifting bail from inside machine.



! WARNING

**Door under pressure.
Can cause serious injury.** 

Use both hands to open door when machine is running.



! WARNING

**Disconnected air hoses whip.
Can cause serious injury or death.** 

When using air tools attach safety device (OSHA valve) at source of air supply for each tool.



CAUTION

**DO NOT WELD.
ELECTRONIC DAMAGE
WILL OCCUR.**

This engine is equipped with an electronic engine controller and other electronic components.



! WARNING

**Combustible gas.
Can cause serious burns,
blindness or death.** 

Keep sparks and open flames away from batteries.



CAUTION

DO NOT USE ETHER.

ENGINE DAMAGE WILL OCCUR.

This engine is equipped with an electric heater starting aid.



**USE DIESEL
FUEL ONLY**



NOTICE

COOLANT FILL INSTRUCTIONS

Adding:

Do NOT remove radiator cap. Top off at overflow reservoir. Use same anti-freeze mixture as in radiator.

Replacing:

With system cool, remove radiator cap. Drain coolant and close drain. At radiator, refill system. Replace radiator cap. At reservoir, fill to "HOT" level. Run for 30 minutes. Stop and allow to cool. At reservoir, add coolant as necessary to reach "COLD" level.

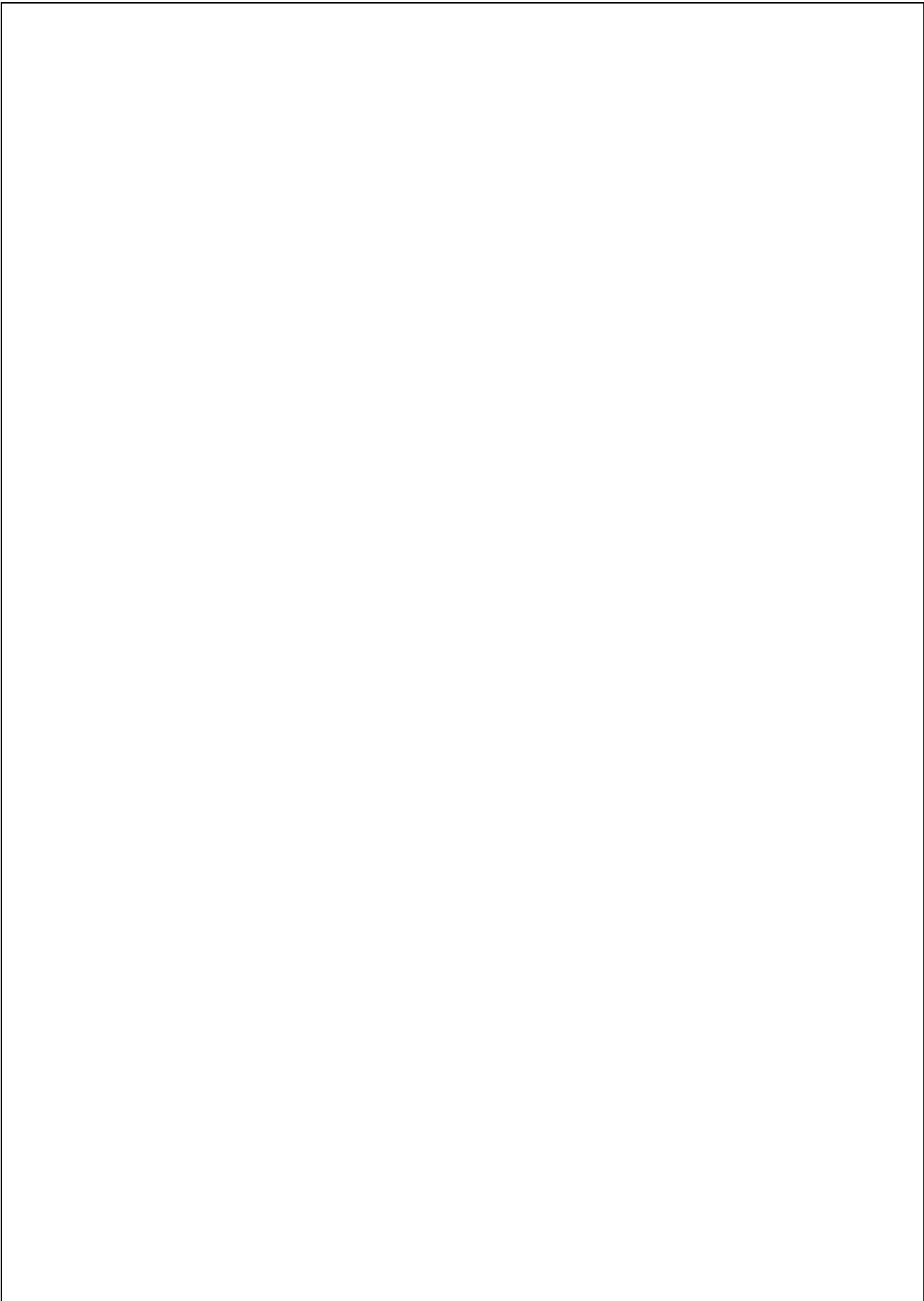



Installation

Installation

System Description - General

The compressor modules are semi-packaged, air-cooled units designed for power take-off applications. Each unit is designed to operate at ambient temperatures from -10° F to 125° F (-23.3° C to 51.7° C). For the actual delivery of each unit at its rated operating pressure, refer to the General Data Decal supplied with each unit.

The unit includes an oil-flooded, rotary, screw-type air compressor, a compressor inlet system, a capacity control system, a compressor lubricating oil system, a compressor discharge system as well as basic instrumentation. The compressor inlet system includes an air intake cleaner with a service indicator. The capacity control system includes a pressure regulator linked to compressor inlet unloader valve. The compressor lubricating oil system includes an air-cooled type oil cooler, an oil filter, and oil control valve and an oil separator tank and air receiver. The oil cooler is of the fin and tube-type construction that requires forced draft cooling air. Some units are supplied with an hydraulic oil cooler.

Basic instrumentation includes compressor discharge air pressure, hour meter, and air restriction indicator.

The enclosure cabinet, in which the components are mounted, is of heavy gauge sheet steel and is equipped with easy opening access panels for performing routine maintenance functions.

Compression in the screw-type air compressor is created by the meshing of two helical rotors (male and female) on parallel shafts enclosed in a heavy-duty cast iron housing with air inlet and outlet ports located at opposite ends. The male rotor has four lobes, 90 degrees apart and the female rotor has six grooves 60 degrees apart. The grooves of the female rotor mesh with and are driven by the male rotor.

Thrust taper roller bearings at the rear of the airend prevent longitudinal movement of the rotors. As rotation of the compressor occurs, the rotors unmesh and free air is drawn into the cavities or pockets between the male rotor lobes and the grooves of the female rotor.

The air is trapped in these pockets and follows the direction of rotation of each rotor. As soon as the inlet port is closed, the compression cycle begins and the trapped air is directed to the opposite or discharge side of the rotor housing.

As the rotors mesh, the normal free volume of air is decreased and the pressure increased until the closing pocket reaches the discharge port. Cooled lubricating oil is admitted to the compressor by being injected, in metered amounts, directly into the rotor housing so that it passes on with the air being compressed. This removes the heat of compression to a large degree and results in a relatively low, final discharge air temperature.

Since the American Hydraulic Compressor Module Series unit is of the positive displacement type, an airflow control system must be provided to regulate the volume of air passing through the compressor to match the amount of service air required by the customer.

Constant speed control unloads the compressor at a predetermined pressure while the driving unit continues to operate at full speed. An air operated regulator closing off the intake to the compressor in an infinitely variable or stepless manner through the inlet unloader valve accomplishes this.

The discharge air pressure can be controlled between 80 and 150 psig (552 to 1034 kPa) by simple readjustment of the pressure regulator adjusting screw. Unit is shipped set at 125 psig (1005 kPa).

Mounting Unit

Satisfactory installation depends upon the ability of the installer. Refer to the appropriate foundation plan for the dimensions of the compressor package.

Choose a clean, relatively cool location for the compressor package, and provide ample space around the unit for general accessibility and to ensure effective heat dissipation. Extreme care must be taken in locating an air-cooled unit of this type so there is an unrestricted supply of air to the cooling fan, which pulls air over the oil cooler core. The fan discharge air must flow away from the unit so that it may be readily dissipated to atmosphere without recirculating hot air to the fan intake. **Any recirculation of the cooling air may result in an excessively high compressor operating temperature.** The compressor package must be located so the instrument panel will be fully visible.

Exact level is not absolutely necessary, but it is recommended the unit be leveled with a sight glass or a carpenter's level set on the compressor housing. Leveling may be accomplished by shimming the unit near the unit's bolting holes. Be sure to use steel shims. Mounting holes are provided on the bottom of the base.

Sufficient space must be provided at the top of the unit to service the air cleaner, oil filter, and separator element.

The spin-on separator requires the most clearance -about 200mm from the roof surface. The oil filter and air filter are both shorter. For installations such as under the bed of a truck, it may be desirable to provide a sliding mount tray for the compressor to facilitate servicing. For this type mounting care must be exercised to provide adequate piping and wiring slack to allow the unit to move for service.

It is normally not necessary to mount the unit to the vehicle or machine with "soft" isolators. This is especially true with trucks and other equipment mounted on rubber tires. Drilling equipment installations also normally work well with direct hard mounting. For some applications where shock and/or vibration is significant, such as an excavator or other track-mounted machine, it may be desirable to soft mount the unit for its protection. In this case, isolators should be placed at each corner of the compressor, using the supplied mounting holes. The static weight on each isolator will be approximately 85 lbs. Appropriate mounts should be rated in the 125 to 150 lbs. static range.

Compressor noise levels will not benefit from using isolators on low shock and vibration applications such as a truck, due to the inherent low vibration signature of this compressor.

Inlet Piping

Each unit is supplied with an air cleaner to protect the compressor from normal airborne dust and dirt. If necessary, the air cleaner may be removed and remotely mounted for ease in accessibility.

Piping - General

AMHC Compressor Module units will require customer provided piping from the compressor module to the hydraulic supply and the air service piping. These hoses are not provided with the units, as the required lengths of the hoses are dependent on the relative locations of modules in its installed location. It is left to the installer to obtain hoses of the correct type and length for each installation.

Location	Fitting Size	Hose Size	Hose Type
Compressor Module to Hydraulic Supply	-12 JIC	3/4" (-12)	Parker-Hannifin 301 or equivalent
Compressor Module to Tank Return	-16 JIC	1" (-16)	Parker-Hannifin 301 or equivalent
Compressor Module to Discharge	12 JIC	3/4" (-12)	Parker-Hannifin 213, or Aeroquip FC350, or equivalent
Motor Case Drain	4 JIC	1/4" - 4	Parker-Hannifin 213, or Aeroquip FC350, or equivalent

All hoses terminate at marked bulkhead fittings.

All hoses terminate in Type 1 SAE J516 (female swivel), 37 -JIC flare fittings.

3/4-inch NPT to -JIC adapter and fitting for airend discharge pipe is customer supplied.

Compressor Discharge Piping

The customer must furnish the connection between the compressor package and the customer air system. It is recommended the customer use a flexible line of 3/4-inch or larger. All piping must be certified safe for the pressures and temperatures involved.

Wiring

The unit is provided with a pigtail harness that is to be hard-wired into the chassis of the vehicle. The pigtail is 20 ft. in length. All excess wire should be cut from the pigtail during installation in order to reduce voltage drop to the compressor. The wiring of the pigtail is 14 AWG. The brown wire is connected to a sure ground on the vehicle. The yellow wire is connected to the customer provided compressor ON-OFF switch, and should be routed through an inline fuse rated at 10 amps. The ON-OFF switch is in turn connected to the vehicle +12 VDC battery post via a switched circuit (power available when vehicle ignition switch is ON). The blue wire is used as a +12 VDC signal to a relay or other device when a vehicle throttle control is used. When the compressor is running, the blue wire has power, signaling the throttle control to advance the throttle to the compressor operating setting. When the compressor is shut down, the engine throttle is relaxed to return the engine to idle.

The compressor is protected against overheating by a thermal-type discharge air temperature switch located in the compressor receiver/separator. A "normally-closed" type thermal switch, factory set at 248° F (120° C), is supplied as standard equipment on these units. This switch is supplied for 12-volt DC.

The safety shutdown function of the unit is completely internal to the module, and operates by de-energizing the hydraulic diverter solenoid valve to make the hydraulic flow bypass the motor.

Regulation

The standard regulation system supplied with the compressor module units is designed to provide capacity control for the compressor only. Variable speed control of a driver engine is possible with additional equipment. Consult Portable Power Aftermarket Department for technical assistance for these applications.

The adjustment and operation of the standard regulation system is described in the operating instructions.

As noted therein, the unit is shipped from the factory adjusted to 125 psig discharge pressure. The operator may adjust for operation from 80 to 150 psig.

Hydraulic Cooling Requirements

Every hydraulic system generates waste heat due to normal mechanical (friction) and volumetric (slippage) losses. In a typical circuit used to operate the air compressor, losses occur in the compressor hydraulic motor, customer's hydraulic pump used to drive the motor, and the piping pressure drops.

These losses can be reduced by specifying efficient (both mechanically and volumetrically for pumps and motors) components for the hydraulic system. The compressor motor was chosen in great part due to high efficiency. Using large hoses helps. Do not use hoses smaller than the connecting fittings on the compressor.

This model is supplied with a built-in hydraulic oil cooler. It is designed to maintain the oil at no more than 60°F (33°C) above ambient air temperature at full compressor load.

Hydraulic Oil Requirements

Most premium grade petroleum based hydraulic fluids can be used with the American Hydraulic Compressor Module unit. Optimum operating viscosity is in the range of 16-40cSt (74- 185SSU). Minimum operating viscosity is 10cSt (59SSU). Maximum operating viscosity is 750cSt (3409 SSU). Maximum cold start viscosity is 2000cSt (9240 SSU). Fluids should be chosen based on starting viscosity at lowest anticipated oil temperature. Normally, ISO 32 grade fluids are a good choice as they are usable for starting down to -10° F, and can operate up to about 175°F, which covers the range of hydraulic temperature with a cooler temperature on a 100°F+ day. For sustained low temperature (freezing or colder), it is recommended that ISO 15 or ISO 22 be used. Also usable are multi-viscosity oil rated 5w-20. ISO 15 oil must not be used at ambient temperatures over 80°F. ISO 22 is limited to an upper ambient of 100°F. For sustained operation in high ambient temperatures, ISO grade 46 fluid is a good choice. The motor in the compressor module unit can operate continuously at 200° F and intermittently at 221° F. However, as previously stated it is desirable to limit the oil temperature to no more than 175° F. This will enhance the life of the hydraulic system, and less speed drop-off will occur at high ambient temperature.

Hydraulic Reservoir

Hydraulic reservoir for the compressor alone should be in the 20-30 gallon size range at a minimum, and larger if space and weight considerations allow. If other motors feed simultaneously from the same tank, it should be sized proportionately larger to handle the additional flow. Follow established design practice for tank layout. Inlet and outlet connections should be well separated, and tank should be baffled. It is desirable that an outlet strainer be fitted. A cut off valve for service should be included, along with a clean-out port. Tank must be vented to atmosphere and should include adequate expansion volume. Return case drain below oil level.

Some speed decrease at higher temperatures is normal due to reduced volumetric efficiency of the pump and motor as they handle lower viscosity oil. Using higher viscosity grades of hydraulic oil for high ambient operation can minimize this.

Hydraulic Filtration

In addition to a tank strainer, a hydraulic filter must be fitted either in the return line or in the pressure line. We highly recommend pressure side filtration to better protect the motor and diverter valve (both of which have close tolerance parts) from any particles that get through the tank strainer or are generated in the pump. Filter should have a nominal rating of 5-10 micron. Specifically, Absolute Rating per ISO 16889 (new) should be 5-10 for Bx(c)>200. Flow rating should be for a minimum of 20GPM. Connect the filter inline with the pressure line going to the hydraulic oil inlet of the compressor. Do not install low pressure rated filter assembly into high pressure hydraulic supply line. It will fail immediately upon startup. Low pressure filter units are for return line service only.

HP60CMH Hydraulic Flow Schematic

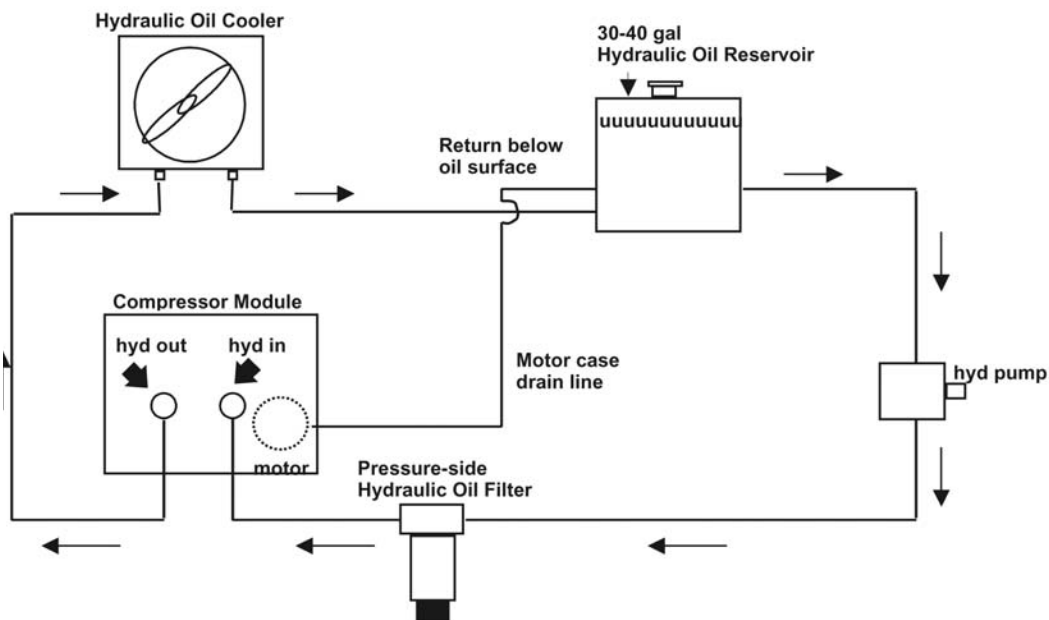



General Data

General Data

Unit Models

Unit Model	HP60CMH
Rated Delivery cfm (liters/sec)	60 (28.3)
Max Rated Pressure psi (kPa)	150 (1034)

Input Power Requirements @ full load:

Horsepower	20
Motor Speed (RPM)	2500
Airend Speed (RPM)	7115

Hydraulic Motor Requirements (at full load)

GPM @ psi	18.1 (2295)
LPM at kPa	68.5 (15829)

Compressor Lube Capacity (Refill) U.S. gal (liters):

1 (3.8)

Unit Measurements/Weights:

Overall Length inch (mm)	28.7 (729)
Overall Height - inch (mm)	23.6 (600)
Overall Width - inch (mm)	21.6 (549)
Weight - (Compressor Module) pounds(kgs)	328 (149)
Weight - (system with lubricants) - pounds (kgs)	336 (152)

Service Parts:

Compressor Oil Filter Element	39329602
Compressor Oil Separator Element	22388045
Air Cleaner Element	22173538



Operating Instructions

Operating Instructions

Set-Up

Place the unit in an open, well-ventilated area. Position as level as possible. The design of these units permits a 15-degree sidewise limit on out-of-level operation.

When the unit is to be operated out of level it is important:

1. To have the compressor oil level gauge show no more than mid-scale.
2. Do not overfill the compressor lubricating oil system.

Before Starting

CAUTION

Do not connect the air discharge on this unit into a common header with any other unit of any description, or any other source of compressed air, without first making sure a check valve is used between the header and the unit. If this unit is connected in parallel with another unit of higher discharge pressure and capacity, a safety hazard could occur in a back-flow condition.

Safety valve setting is 200 psig (1379 kPa). Assure external air system is safe under all operating conditions to prevent serious hazard to operations personnel.

WARNING

Unrestricted airflow from a hose will result in a whipping motion of the hose, which can cause serious injury or death. A safety device must be attached to the hose at the source of supply to reduce pressure in case of hose failure or other sudden pressure release. Reference: OSHA regulation 29 CFR Section 1926.302 (b).

- Ensure pressure is relieved in receiver separator system. Open service valve or manual blowdown valve if necessary to relieve pressure. Close valve(s) in order to build up full air pressure and ensure proper oil circulation.
- Check the compressor lubricating oil level. The proper oil level is mid-way to full on the sight glass. Add oil if the level falls below. Do NOT overfill.

 **WARNING**

This machine produces loud noise. Extended exposure to loud noise can cause hearing loss. Wear hearing protection.

Be sure no one is IN or ON the compressor unit.

Always operate this equipment with all enclosure panels installed to avoid leakage of cooling air. Operation with panels or access covers removed will quickly result in overheating.

 **WARNING**

Do NOT operate machine with guards removed.

 **CAUTION**

Do not operate machine with safety shutdown switches by-passed.

Starting/Operating

- Close service valve.
- Engage hydraulic pump at lowest possible driver speed

 **CAUTION**

Do NOT engage compressor motor at driver speed above idle. Damage to compressor motor, pump, or other driveline components can occur.

- Engage customer supplied ON/OFF switch.
- Increase driver speed to compressor operation rated speed.
- Allow compressor to run unloaded five (5) to ten (10) minutes.
- Compressor is now ready to furnish compressed air when service valve is opened.

Stopping

- Close air service valve(s).
- Allow the unit to run at “no load” for 3 to 5 minutes to reduce the compressor temperature.
- Turn customer supplied ON/OFF switch OFF.
- Disengage hydraulic pump.

NOTE: Once the drive motor stops, the automatic blow-down valve will begin to relieve all pressure from the receiver separator system.



Never allow the unit to sit stopped with pressure in the receiver separator system. Never shut down unit while running loaded. Flooding of separator element can result.

Equipment Protection

NOTE: Do NOT wire around or bypass a shutdown sensor or switch.

This unit is protected by a shutdown switch at the following location:

High Discharge Air Temperature

1. In the top of the integral separator tank.

Gauge Panel

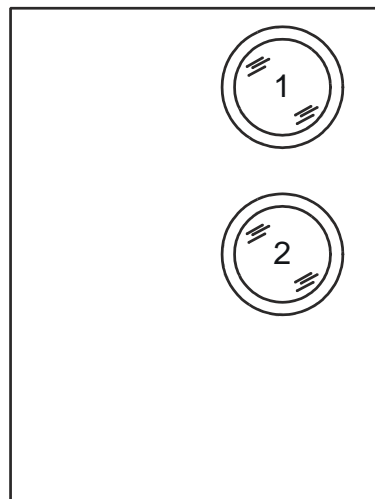

Operating Instruments

On Panel

1. Compressor Discharge Pressure Gauge - Indicates pressure in receiver tank, psig (kPa).
2. Hour meter - Indicates elapsed unit operating time.

Inside

3. Air Filter Restriction Indicator - Indicates compressor air cleaner restriction.
Normal operation (<20-in. H₂O), green flag.
Needs service, (>20-in. H₂O), red flag.
(Indicator located at base of inlet filter).

Speed and Pressure Regulator Adjusting Instructions

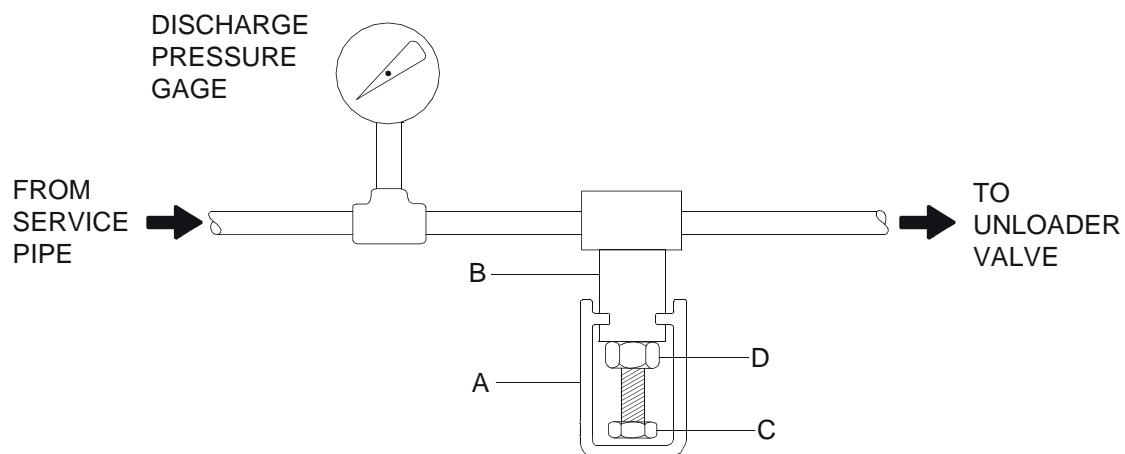

Normally, pressure regulation requires no adjusting, but if proper adjustment is lost, proceed as follows. Refer to the General Data table for proper engine speeds.

Before Starting

1. Remove regulator valve cover (A), (if equipped) on valve (B) to expose adjusting screw (C). Loosen jam nut (D) on adjusting screw (C) and turn screw counterclockwise until tension is no longer felt on screw. Now, turn screw clockwise one full turn.
2. Close service valve(s).

After Starting Unit

3. Allow unit to warm up at least five minutes, and then if equipped, place the Start-Run Valve Switch in the "AIR" position to obtain full service air pressure.
4. With Service Air Valve closed, turn the adjusting screw (C) clockwise until the discharge pressure reaches 160 psi (range =10psi). Tighten jam nut (D).
5. Replace regulator valve cover (A), if equipped.
6. To select any pressure range fro 80 to150 psi, change adjusting screw (C) to obtain a "closed" service valve pressure that is 10 psi greater than the desired "working" service pressure. Always lock and protect pressure setting of adjusting screw (C) with jam nut (D) and regulator valve cover (A).

NOTE: Unit is adjusted at factory for operation at 125 psi.



Maintenance/Lubrication

Maintenance/Lubrication

CAUTION

Any unauthorized modification or failure to maintain this equipment may make it unsafe and out of factory warranty.

WARNING

If performing more than visual inspections, disconnect driver engine battery cables and open manual blowdown valve.

Use extreme care to avoid contacting hot surfaces (heat ex-changer and piping, air receiver and air discharge piping).

Never operate this machine with any guards removed.

Inch and metric hardware was used in the design and assembly of this unit. Consult the parts manual for clarification of usage.

General

In addition to periodic inspections, many of the components in these units require periodic servicing to provide maximum output and performance. Servicing may consist of pre-operation and post-operation procedures to be performed by the operating or maintenance personnel. The primary function of preventive maintenance is to prevent failure, and consequently, the need for repair. Preventive maintenance is the easiest and the least expensive type of maintenance. Maintaining your unit and keeping it clean at all times will facilitate servicing.

Scheduled Maintenance

The maintenance schedule is based on normal operation of the unit. In the event unusual environmental operating conditions exist, the schedule should be adjusted accordingly.

Compressor Oil

The lubricating and cooling oil must be replaced every 1000 hours of operation or six (6) months, whichever comes first.

Compressor Oil Level

The oil level should be checked before the unit is operated. The optimum operating level is between mid and high level of sight glass. If the oil level is not in the correct range, make appropriate corrections (add or drain).

NOTE: It is NOT possible to accurately read oil level in tank while compressor is running.

Aircleaner

This unit is equipped with an AIR FILTER RESTRICTION INDICATOR on the clean air side of the compressor air inlet.

This should be checked daily during operation. If the indicator shows (red) with the unit operating at full speed, servicing of the cleaner element is necessary.

If flagged, the air filter restriction indicator must be reset after unit is shutdown and the air cleaners are serviced. Reset by pushing button on top of indicator.

To service the air cleaner on all units proceed as follows:

1. Remove access cover on top of housing.
2. Remove air cleaner top, rotating counter clockwise by hand. Remove element.
3. Wipe inside of air cleaner housing with a clean, damp cloth to remove any dirt accumulation, especially in the area where the element seals against the housing.
4. Inspect the element by placing a bright light inside and rotating slowly. If any holes or tears are found in the paper, discard this element. If no ruptures are found, the element can be cleaned.
5. Check new air filter elements for any shipping damage.
6. Install new element in the reverse order to the above. Tighten cover until it snaps into locked position.

The air cleaner system (housing and piping) should be inspected every month for any leakage paths or inlet obstructions. Make sure the air cleaner mounting clamp is tight. Check the air cleaner housing for damage, which could lead to a leak.

Gauges

The instruments or gauges are essential for safety, maximum productivity and long service life of the machine. Inspect the gauges prior to start-up. During operation observe the gauges for proper functioning. Refer to Operating Controls & Instruments for the normal readings.

Compressor Oil and Hydraulic Oil Combination Cooler

The compressor lubricating and cooling oil and the hydraulic oil are cooled by means of fin and tube-type oil coolers. The lubricating and cooling oil, flowing internally through the core section, is cooled by the air stream from the cooling fan flowing past the core section. When grease, oil and dirt accumulate on the exterior surfaces of the oil cooler, its efficiency is impaired.

Each month it is recommended that the oil cooler be cleaned by directing compressed air which contains a non-flammable safety solvent through the core of the oil cooler. This should remove the accumulation of grease, oil and dirt from the exterior surfaces of the oil cooler core so that the entire cooling area can transmit the heat of the lubricating and cooling oil to the air stream.

In the event foreign deposits, such as sludge and lacquer, accumulate in the oil cooler to the extent that its cooling efficiency is impaired, a resulting high discharge air temperature is likely to occur, causing shut down of the unit.

To correct this situation it will be necessary to clean it using a cleaning compound in accordance with the manufacturer's recommendations. After completing the cleaning procedure, the oil cooler must be flushed before returning to service.

Hoses

Each month it is recommended that the air cleaner clamps be checked for tightness.

Premature wear of the compressor is ASSURED whenever dust-laden air is permitted to enter the compressor intake.

The flexible hoses, oil and air lines on these units are primarily used for their ability to accommodate relative movement between components. It is important they be periodically inspected for wear and deterioration. It is also important the operator does not use the hoses as convenient hand hold or steps. Such use can cause early cover wear and hose failure.

NOTICE

Piping systems operating at less than 200 psi (1050kPa) may use a special nylon tubing. The associated fittings are also of a special "push-in" design. If so, features are as follows:

Pulling on the tubing will cause the inner sleeve to withdraw and compress, thus tightening the connection. The tubing can be withdrawn only while holding the sleeve against the fitting. The tubing can be removed and replaced numerous times without losing its sealing ability.

To install the nylon tubing, make a mark (with tape or grease pencil) approximately 7/8-inch from the end of the tubing. Insert the tubing into the sleeve and "push-in" past the first resistance to the bottom. The mark should be approximately 1/16 inch from the sleeve, for the 3/8-inch O.D. tubing; 1/8-inch for the 1/4-inch O.D. tubing. This will ensure that the tubing is fully engaged in the sealing mechanism.

Compressor Oil Filter

NOTICE

The oil filter must be replaced every 500 hours of operation or three (3) months, whichever comes first. On new or overhauled units, replace the element after the first 50 and 150 hours of operation; thereafter, service the oil filter every 500 hours.

To service the oil filter, it will first be necessary to shut the unit down. Wipe off any external dirt and oil from the exterior of the filter to minimize any contamination from entering the lubrication system. Proceed as follows:

WARNING

High pressure air can cause severe injury or death from hot oil and flying parts. Always relieve pressure before removing caps, plugs, covers or other parts from pressurized air system.

1. Open the service air valve and manual blow down valve to ensure that system is relieved of all pressure. Close the valve.
2. Turn the spin-on filter element counter clockwise to remove it from the filter housing. Inspect the filter.

NOTICE

If there is any indication of formation of varnishes, shellacs or lacquers on the oil filter element, it is a warning the compressor lubricating oil has improper characteristics and should be immediately changed.

3. Inspect the oil filter head to be sure the gasket was removed with the oil filter element. Clean the gasket seal area on the oil filter head.

NOTICE

Installing a new oil filter element when the old gasket remains on the filter head, will cause an oil leak and can cause property damage.

4. Lubricate the new filter gasket with the same oil being used in the machine.

5. Install new filter by turning element clockwise until gasket makes initial contact. Tighten an additional 1/2 to 3/4 turns.
6. Start unit and allow to build up to rated pressure. Check for leaks before placing unit back into service.

Fasteners

Visually check entire unit in regard to bolts, nuts and screws being properly secured. Spot-check several cap screws and nuts for proper torque. If any are found loose, a more thorough inspection must be made. Take corrective action.

Receiver-Separator Systems

WARNING

High-pressure air can cause severe injury or death from hot oil and flying parts. Always relieve pressure before removing caps, plugs, covers or other parts from pressurized air system.

Open service valve and manual blowdown valve.

Ensure pressure is relieved, when BOTH:

- Discharge air pressure gauge reads zero (0).
- No air discharging from service valve.

When draining oil, open manual blowdown valve to allow venting the system. Close blowdown valve prior to re-starting compressor.

When adding oil, remove and replace (make tight) plug on side of separator tank.

In the compressor lubricating and cooling system, separation of the oil from the compressed air takes place in the receiver-separator tank. As the compressed air enters the tank, the change in velocity and direction drop out most of the oil from the air.

Additional separation takes place in the spin-on oil separator element, which is located on the top of the tank.

Any oil accumulation in this separator element is continuously drained off by means of a scavenge drain which returns the accumulated oil to the system.

Scavenge Line

WARNING

High-pressure air can cause serious injury or death from hot oil and flying parts. Always relieve pressure before removing caps, plugs, covers or other parts from pressurized air system.

The scavenge line originates at the base of the spin-on separator element head, and terminates at the compressor airend inlet valve through an orifice/check valve.

Once a year or every 2000 hours of operation, whichever comes first, remove this line and any orifice, thoroughly clean, then reassemble.

NOTICE

Excessive oil carryover may be caused by an oil logged separator element. Do not replace element without first performing the following maintenance procedure:

1. Check oil level. Maintain as indicated earlier in this section.
2. Thoroughly clean scavenge line, orifice and check valve.
3. Assure minimum pressure valve is holding 80 to 90 psi.
4. Run unit at rated operating pressure for 30 to 40 minutes to permit element to clear itself.

Oil Separator Element

The life of the oil separator element is dependent upon the operating environment (soot, dust, etc.) and should be replaced every twelve months or 2000 hours. To replace the element proceed as follows:

* Ensure the tank pressure is zero.

1. Remove roof access cover.
2. Using strap wrench if necessary, remove spin on separator unit by rotating counterclockwise.

NOTE: If there is any indication of formation of varnishes, shellacs or lacquers on the oil filter element, it is a warning the compressor lubricating oil has improper characteristics and should be immediately changed.

3. Inspect the separator head to be sure the gasket was removed with the oil filter element. Clean the gasket seal area on the head.

NOTE: Installing a new separator element when the old gasket remains on the filter head, will cause an oil leak and can cause property damage.

4. Lubricate the new filter gasket with the same oil being used in the machine.
5. Install new separator by turning element clockwise until gasket makes initial contact. Tighten an additional $\frac{1}{2}$ to $\frac{3}{4}$ turns.
6. Adjust oil level if necessary.
7. Start unit and allow to build up to rated pressure. Check for leaks before placing unit back into service.

Exterior Finish Care

This unit was painted and heat cured at the factory with a high quality, thermoset polyester powder coating. The following care will ensure the longest possible life from this finish.

1. If necessary to remove dust, pollen, etc. from housing, wash with water and soap or dish-washing liquid detergent. Do not scrub with a rough cloth, pad, etc.
2. If grease removal is needed, a fast evaporating alcohol or chlorinated solvent can be used. Note: This may cause some dulling of the paint finish.
3. If the paint has faded or chalked, the use of a commercial grade, non-abrasive car wax may partially restore the color and gloss.

Drive Belt

The drive belt is a six groove, long life, “K” section poly-V unit that transmits power from the hydraulic drive motor to the input shaft of the airend. As the cooling fan is attached to the airend input shaft, the belt also provides motive power for the fan.

Occasionally, it is important to check that the tension in the belt is proper. A force gauge manufactured for this purpose may be used, or a simple spring scale may be employed. The belt is checked by putting a measured force onto the belt, perpendicular to the span, halfway between the span between the drive and driven pulleys. At the same time the deflection of the belt is measured.

Tension according to the following chart:

Force/Deflection for Drive Belt				
New Belt		Used Belt		
Deflection Force		Deflection Force		
Minimum	Maximum	Minimum	Maximum	Deflection
10.4 LB	11.2 lb	9.0 lb	9.7 lb	0.151 in

The belt tension adjustment is via movement of the motor assembly. To adjust, loosen the four M8 bolts that secure the Motor Adjusting Bracket to the Motor Mounting Bracket. Remove the plastic hole cover at the corner of the machine over the adjusting nut. Turn the nut clockwise to tighten the belt or counter-clockwise to loosen. After proper tension is achieved, retighten the four MB bolts to lock the motor in position. Reinstall the plastic cover to prevent leakage of cooling air.

Field Repair Texture Paint

1. The sheet metal should be washed and clean of foreign material and then thoroughly dried.
2. Clean and remove all grease and wax from the area to be painted using Duponts 3900S Cleaner prior to sanding.
3. Use 320 grit sanding paper to repair any scratches or defects necessary.
4. Scuff sand the entire area to be painted with a red scotch brite pad.
5. Wipe the area clean using Duponts 3900S.
6. Blow and tack the area to be painted.
7. Apply a smooth coat of Duponts 1854S Tuffcoat Primer to all bare metal areas and allow to dry.

 **WARNING**

If performing more than visual inspections, disconnect battery cables and open manual blowdown valve.

Never operate this machine with any guards removed.

 **CAUTION**

Use extreme care to avoid contacting hot surfaces, air receiver and air discharge piping, etc).

Inch and metric hardware was used in the design and assembly of this unit. Consult parts manual for clarification of usage.

Maintenance Schedule

	Daily	Monthly	3 MOS. 500 hrs.	6 MOS. 1000 hrs	12 MOS. 2000 hrs.
Compressor Oil Level	C				
Gauges/Lamps	C				
*Air Cleaner Service Indicators	C				
Hoses (oil, air, intake, hydraulic, etc.)		C			
Automatic Shutdown System Test		C			
Air Cleaner System Visual		C			
Hydraulic Oil Cooler Exterior		C	Clean		
Fasteners			C		
Air Cleaner Elements			WI		
Compressor Oil Filter Element			R		
Compressor Oil				R	
Shutdown Switch Setting Test					C
Scavenger Orifice & Related Parts					Clean
Oil Separator Element					R
* Disregard if not appropriate for this particular machine.					
R = replace, C = check (adjust if necessary), WI = OR when indicated, L = Lubricate					

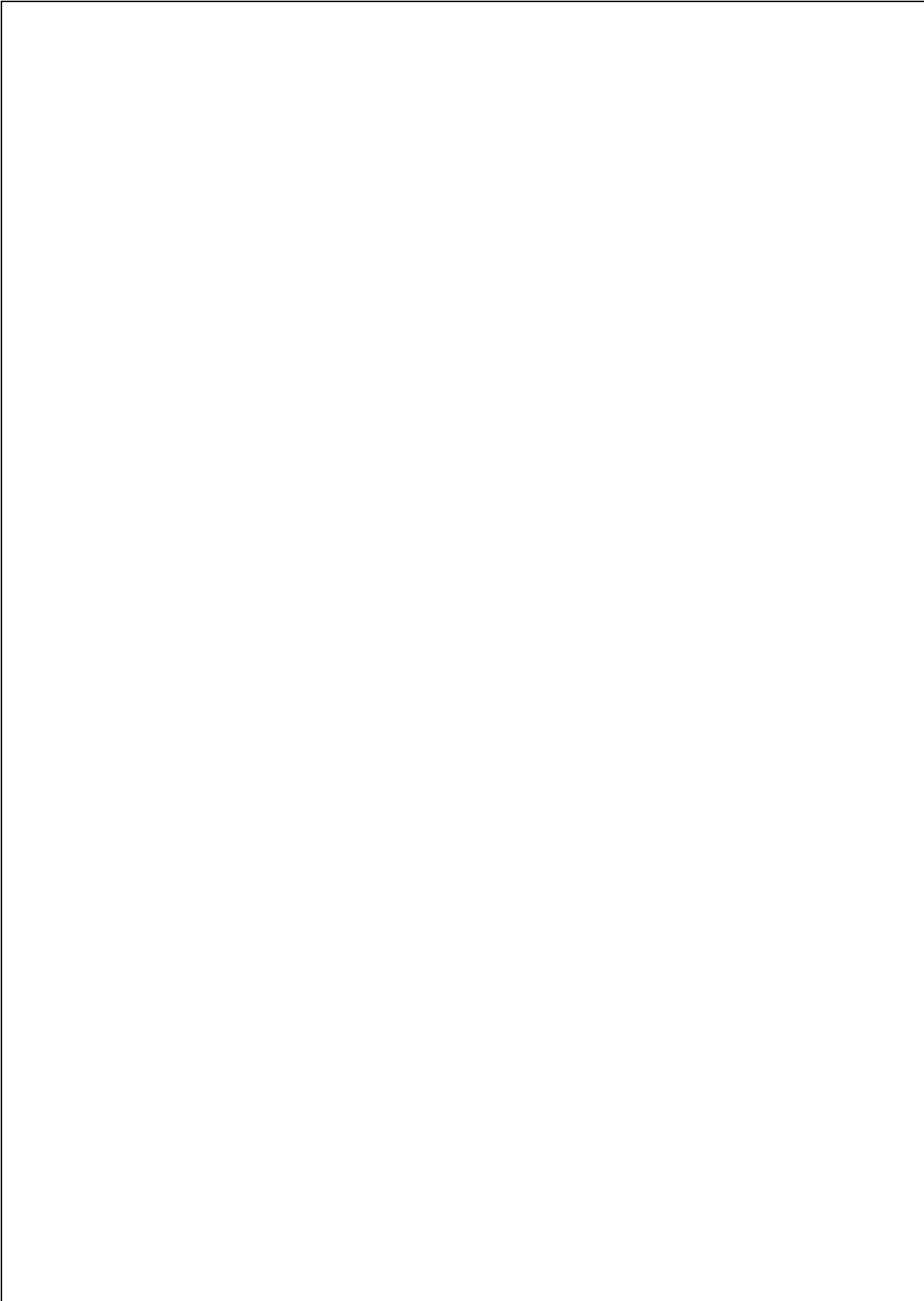



Lubrication

Lubrication

General Information

The compressor lubricating oil accomplishes both compressor lubrication and cooling. The oil is forced from the oil storage reservoir, under system pressure, through an oil cooler and an oil filter directly to the compressor.

When the compressor is operating at low capacity, some of the oil may bypass the cooler through a thermostatically controlled bypass valve. This valve bypasses varying amounts of oil, depending upon the temperature, until the oil being circulated reaches a temperature of 185° F (85° C) thus maintaining a higher average oil temperature, thereby reducing the possibility of water vapor condensation in the oil.

Relatively cool lubricating oil is admitted under pressure to the compressor bearings and is also injected in metered amounts, directly to the rotor chamber. All of the oil thus introduced mixes with, and passes on with the air being compressed, thus removing the heat of compression to a large degree. On its way to the final discharge connection, the air passes through a receiver/separator. A scavenger line returns any remaining separated oil back to the inlet of the compressor.

Fill the oil storage reservoir in the receiver/separator with new oil before operating the unit. Recharge the compressor by first removing the air filter and pouring about one pint (0.55 liter) of oil into the compressor inlet.

NOTE: Recharging of the compressor with oil is absolutely necessary on units that have been placed in extended storage (6 months or more).

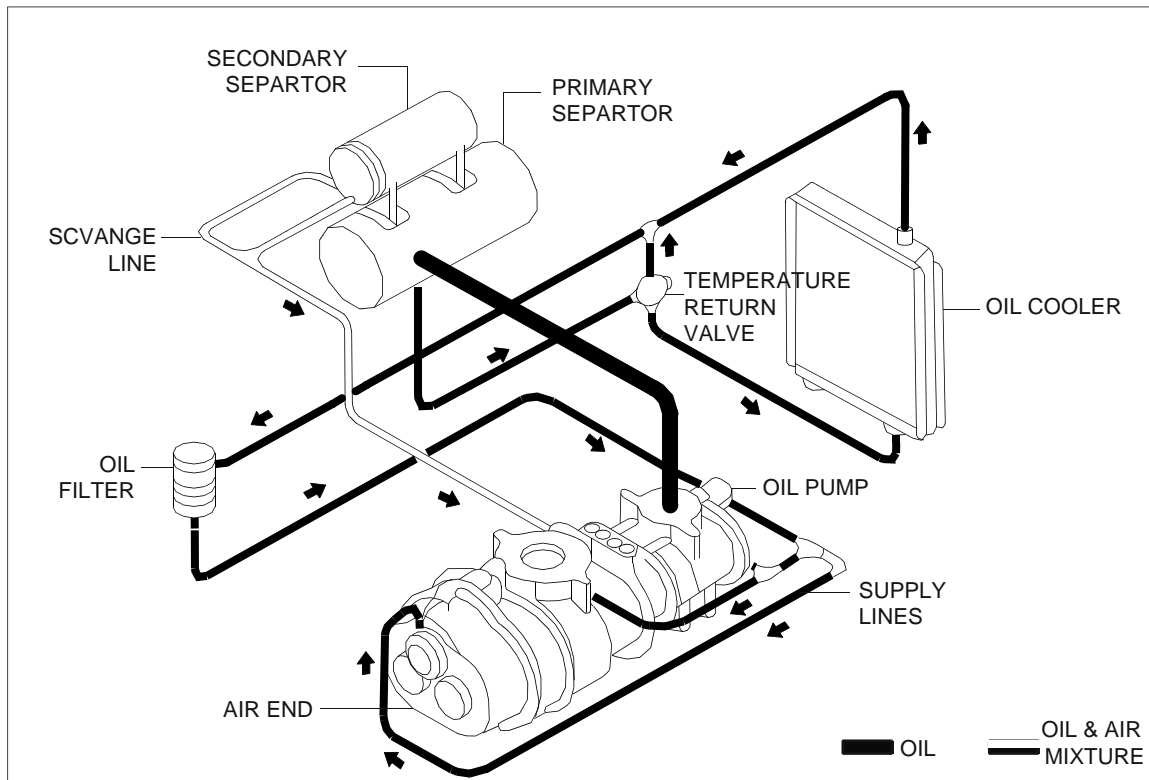

Compressor Oil Change

If the unit has been operated for 1000 hours, it should be completely drained of oil. If the unit has been operated under adverse conditions or under long shutdown periods, an earlier change may be necessary as oil deteriorates with time as well as by operating conditions.

Complete replacement of the old oil with clean oil every 500 to 1000 hours, depending upon operating conditions is recommended. This will also prevent accumulation of dirt, sludge or oxidized oil products.

Completely drain the receiver/separator and the piping. If the oil is drained immediately after the unit has been run for sometime, most of the sediment will be in suspension and will drain more readily.

CAUTION

Shorter oil change intervals may be necessary if unit is operated under adverse conditions.

WARNING

Do not under any circumstances, open any drain cocks, remove any plugs or the oil filler plug from the compressor lubricating and cooling oil system without making sure the air receiver system has been completely relieved of all air pressure.

CAUTION

Some oil mixtures are incompatible with each other and result in the formation of varnishes, shellacs or lacquers, which may be insoluble. Such deposits can cause serious trouble including clogging of the filter. Where possible, try to avoid mixing oils of the same type, but different brands. A brand change is best made at the time of complete oil change. Refer to Fluid and Lubricants Chart for oil recommendations.

Portable Compressor Fluid Chart

Refer to these charts for correct compressor fluid required. Note that the selection of fluid is dependent on the design operating pressure of the machine and the ambient temperature expected to be encountered before the next oil change.

Note: Fluids listed as “preferred” are required for extended warranty. Compressor oil carryover (oil consumption) may be greater with the use of alternative fluids.

Design Operating Pressure	Ambient Temperature	Specification
100 psi to 300 psi	-10°F to 125°F (-23°C to 52°C)	Preferred: ISO Viscosity Grade 46 with rust and oxidation inhibitors, designed for air compressor service.
350 psi	-10°F to 125°F (-23°C to 52°C) 65°F to 125°F (18°C to 52°C)	ISO Viscosity Grade 68 Group 3 or 5 with rust and oxidation inhibitors designed for air compressor service.

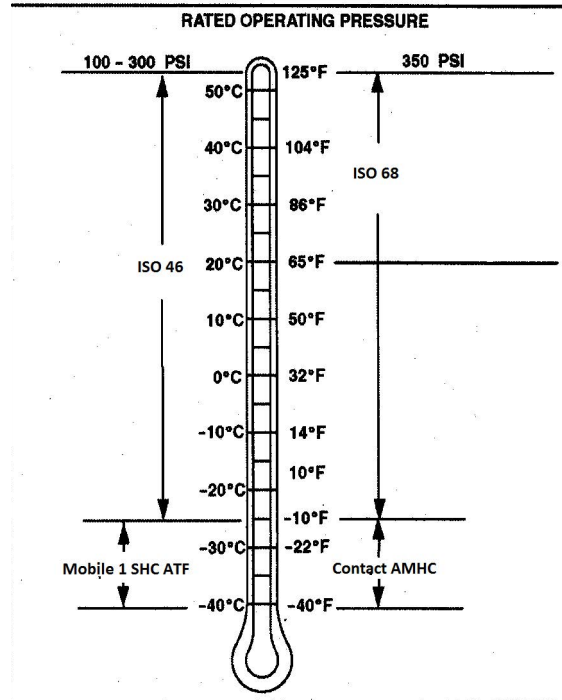



Troubleshooting

Troubleshooting

Introduction

Troubleshooting for a portable air compressor is an organized study of a particular problem or series of problems and a planned method of procedure for investigation and correction. The troubleshooting chart that follows includes some of the problems that an operator may encounter during the operation of a portable compressor.

The chart does not attempt to list all of the troubles that may occur, nor does it attempt to give all of the answers for correction of the problems. The chart does give those problems that are most apt to occur. To use the troubleshooting chart:

- A. Find the “complaint” depicted as a bold heading.
- B. Follow down that column to find the potential cause or causes. The causes are listed in order (1, 2, 3, etc.) to suggest an order to follow in troubleshooting.

Action Plan

A. Think Before Acting

Study the problem thoroughly and ask yourself these questions:

1. What was the warning signals that preceded the trouble?
2. Has a similar trouble occurred before?
3. What previous maintenance work has been done?
4. If the compressor will still operate, is it safe to continue operating it to make further checks?

B. Do the Simplest Things First

Most troubles are simple and easily corrected. For example, most complaints are “low capacity” which may be caused by too low an engine speed or “compressor over-heats” which may be caused by low oil level.

Always check the easiest and most obvious things first; following this simple rule will save time and trouble.

NOTE: For troubleshooting electrical problems, refer to the wiring Diagram Schematic found in Parts List Section.

C. Double Check Before Disassembly

The source of most compressor troubles can be traced not to one component alone, but to the relationship of one component with another. Too often, a compressor can be partially disassembled in search of the cause of a certain trouble and all evidence is destroyed during disassembly. Check again to be sure an easy solution to the problem has not been overlooked.

D. Find and Correct Basic Cause

After a mechanical failure has been corrected, be sure to locate and correct the cause of the trouble so the same failure will not be repeated. A complaint of "premature breakdown" may be corrected by repairing any improper wiring connections, but something caused the defective wiring. The cause may be excessive vibration.

Troubleshooting Chart

Bold Headings depict the COMPLAINT - Subheadings suggest the CAUSE

NOTE: Subheadings suggest sequence to follow troubleshooting.

Short Air Cleaner Life:

Dirty Operating Conditions
 Inadequate Element Cleaning
 Defective Service Indicator
 Incorrect Stopping Procedure
 Wrong Air Filter Element

Excessive Oil In Air:

Out of Level > 15 degrees
 Clogged Scavenge Orifice
 Scavenge Tube Blocked
 Defective Scavenge Check Valve
 Separator Tank Blown Down too Quickly
 Defective Minimum Pressure Valve

Will Not Unload:

Leak in Regulator Piping
 Incorrect Pressure Regulator Adjustment
 Malfunctioning Pressure Regulator
 Malfunctioning Inlet Unloader Butterfly Valve
 Ice in Regulation Lines/Orifice

Oil In Air Cleaner:

Incorrect Stopping Procedure

Safety Valve Relieves:

Operating Pressure too High
 Leak In Regulator Piping
 Incorrect Pressure Regulator Adjustment
 Malfunctioning Pressure Regulator
 Malfunctioning Inlet Unloader/Butterfly Valve
 Defective Separator Element
 Ice in Regulation Lines/Orifice

Excessive Compressor Oil Temperature:

Ambient Temperature too High
 Out of Level > 15 degrees
 Low Oil Level
 Wrong Lube Oil
 Dirty Cooler
 Dirty Operating Conditions
 Clogged Oil Filter Elements

Defective Oil Temperature Bypass Valve
 Defective Minimum Pressure Valve
 Blocked or Restricted Oil Lines
 Airend Malfunctioning

Excessive Vibration:

Defective Fan
 Drive Belt Defective
 Airend Malfunctioning
 Hydraulic Piping too Restrictive

Low CFM:

Low Motor RPM
 Dirty Air Filter
 Incorrect Pressure Regulator Adjustment
 Malfunctioning Inlet Unloader/Butterfly/Valve
 Defective Minimum Pressure Valve
 Defective Separator Element

Unit Shutdown:

Compressor Oil Temperature too High
 Loose Wire Connection
 Defective Discharge Air Temperature Switch
 Airend Malfunctioning
 Compressor Drive Motor Malfunctioning
 Running to Fast

Will Not Start/Run:

Compressor Oil Temperature too High
 Compressor Drive Motor Malfunctioning
 Airend Malfunctioning



American Hydraulic Compressor
PO Box 158
Palisade CO 81526
970-640-7223
www.am-hc.com